

User Manual

Extremely rigid, stable and reliable Slide Kamera HST-3 tripod ideal for indoor and outdoor applications. Specially designed construction allows to stabilize video heads and Slide Kamera devices. All components of the tripod are made with high precision, what ensures high rigidity of the device.

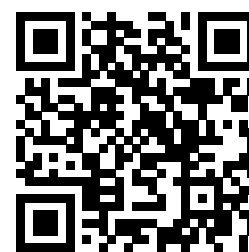

Slide Kamera HST-3 Tripod



Pdf version of the manual available for download: www.slidekamera.eu



made in **POLAND**

1/2014

Before you start your work with Slide Kamera HST-3 tripod we strongly recommend to read the manual carefully. Please note that using the device in a manner inconsistent with the instructions, unauthorized repair attempts or any kind of modification of the device can cause a damage the manufacturer is not responsible for.

In case of damage of Slide Kamera HST-3 tripod during transport you are required to submit:

- proof of purchase
- protective styrofoam inserts/ fillers included in the set in case of new product delivery

If you fail to comply with the abovementioned conditions, the manufacturer reserves the right to refuse the complaint.

Photos of products may slightly differ from the actual product due to constant modifications and improvements introduced by the manufacturer.

Table of contents

1. Elements and construction of Slide Kamera Slide Kamera HST-3 tripod.....	2
2. Additional accessories.....	3
3. Product description.....	4
4. Specification.....	4
5. Setting up the tripod.....	5
5.1. Spreader set-up.....	5
5.2. Extending tripod legs.....	5
5.3. Setting up on uneven ground.....	6
6. Mounting devices on Slide Kamera HST-3 tripod.....	7
7. AF-24 adapter for mounting photo-video accessories on Slide Kamera HST series tripods.....	8
8. Maintenance.....	9
9. Transport.....	9
10. Terms of warranty.....	9

Slide Kamera ®

High Engineering Technology CNC s.c.
Sebastian Pawelec Karol Mikulski
Glina 45
82-522 Sadlinki
Vat Identification Number: 581-188-33-32

Slide Kamera Office

80-175 Gdańsk (Poland)
Ul. Kartuska 386
tel./fax (+48) 58 710 41 04

e-mail: biuro@slidekamera.pl / office@slidekamera.eu
www.slidekamera.pl / www.slidekamera.eu

1. Elements and construction of Slide Kamera Slide Kamera HST-3 tripod

Once the shipment is received please make sure that all the elements of Slide Kamera HST-3 tripod are inside.

Set includes:

- Slide Kamera HST-3 tripod with Slide Kamera HCZ 75mm or 100mm socket
- User Manual

Construction of Slide Kamera HST-3 tripod



- HST-3 tripod crown with Slide Kamera HCZ 75mm or 100mm [1]
- Tripod crown [2]
- Slide Kamera HCZ socket [3]
- Bubble level [4]
- Tripod leg that consists of three double strut leg sections [5]
- Carrying handle [6]
- Clamping lever [7]
- Ground level spreader [8]
- Spreader locking knobs [9]
- Plastic fastening clamp [10]
- Self-aligning feet [11]

2. Additional accessories

Tripod sockets:

- Slide Kamera HCZ-75/100mm socket (Manfrotto system) [1]
- Slide Kamera HCZ-75/100mm socket (Miller system) [2]
- Slide Kamera HCZ-75/100mm socket (Sachtler system) [3]



Adapters:

- Slide Kamera AF-18 leveling adapter [4]
- Slide Kamera AF-16 quick mounting adapter [5]
- AF-24 adapter for mounting photo-video accessories [6]



Bags:

- Slide Kamera PSK-8 [7]



Half ball levelers:

- Manfrotto MN520BALL 75mm [8]
- Manfrotto MN500BALL 100mm [9]



Quick mounting screw:

- Slide Kamera HSZ-2 [10]

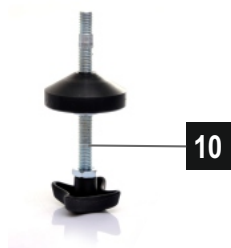

Support:

- HSTA-2 support for Slide Kamera HST series tripods [11]



3. Product description

Extremely rigid, stable and reliable Slide Kamera HST-3 tripod ideal for indoor and outdoor applications. Specially designed construction allows to stabilize video heads and Slide Kamera devices. All components of the tripod are made with high precision, what ensures high rigidity of the device.

Tripod comes with a bubble level and aluminium crown with 75mm or 100mm socket (one to choose from). Aluminium legs of the tripod are equipped with self-aligning feet that allow to set and stabilize the tripod on uneven ground. Additionally, the construction of our tripod allows to set the legs of the device on different heights, what proves extremely useful on uneven ground, hills, stairs etc. Three double strut leg sections provide extra stability and rigidity of the device. Each section comes with a lever equipped with eccentric clamp that allows for easy and stable adjustment of tripod height as well as secures the legs against uncontrolled folding. Slide Kamera HST-3 tripod has a ground level spreader equipped with three locking knobs that help to set legs of the tripod accurately. Slide Kamera HST-3 tripod comes with plastic fastening clamp in the set, that secures the legs during transport.

Slide Kamera HST-3 tripod can be used with different types of video heads thanks to replaceable Slide Kamera HCZ sockets matching systems such as Manfrotto, Sachtler, Miller. However, on client's request, we are able to provide a socket for any type of video head.

4. Specification

Minimum height:	290mm
Maximum height:	1630mm
Leg sections:	3
Tripod socket:	replaceable Slide Kamera HCZ sockets matching systems such as Manfrotto, Sachtler, Miller
Bubble level:	1
Material:	aluminium
Mounting accessories:	Slide Kamera HCZ 75mm or 100mm socket, Three M6 holes
Weight:	7kg
Closed length:	710mm
Spreader:	ground level spreader
Safety Payload:	60kg
Color:	black
Leg lock:	quick release (lock lever)

5. Setting up Slide Kamera HST-3 tripod

Unpack Slide Kamera HST-3 tripod and unlock plastic fastening clamp that secures the legs during transport. Place the device on a flat surface, if possible, and spread the tripod legs. If the setting suits your needs check if all clamping levers [1] and locking knobs are fastened.



5.1. Spreader set-up

In order to spread Slide Kamera HST-3 tripod legs unlock spreader locking knobs and set the legs in a desired position. Ground level spreader allows for even and accurate spacing of the tripod legs. Maximum spacing of the spreader is 620mm with a tripod height: 290mm. Once you have set the spreader properly lock the knobs.

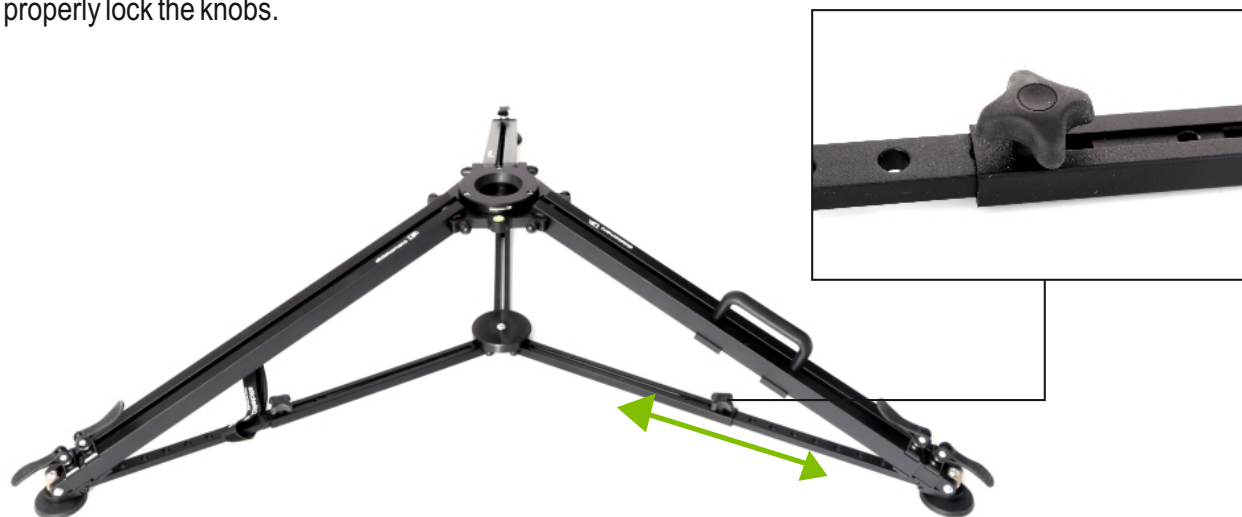

5.2. Extending tripod legs

Slide Kamera HST-3 tripod features a quick and simple system of extending the legs. Each section comes with a lever equipped with eccentric clamp that allows for easy and stable adjustment of tripod height as well as secures the legs against uncontrolled folding. In order set the tripod simply unlock the clamping levers and set the desired height of the tripod. Once you have extended the legs remember to lock all the levers. Slide Kamera HST-3 tripod allows to set the photo-video equipment both low and high to the ground.

Clamping lever unlocked



Clamping lever locked



Range of height of Slide Kamera HST-3 tripod



5.3. Setting up on uneven ground

Aluminium legs of the tripod are equipped with self-aligning rubber feet with high friction coefficient that allow to set and stabilise the tripod on uneven ground. Additionally, the construction of our tripod allows to set the legs of the device on different heights, what proves extremely useful on uneven ground, hills, stairs etc.



Having set the tripod always check if all clamping levers and locking knobs are fastened. It will prevent from uncontrolled folding of the tripod that may ultimately lead to equipment damage.

6. Mounting devices on Slide Kamera HST-3 tripod

Slide Kamera HST-3 tripod allows to mount various accessories in many configurations. You can mount your equipment on the tripod, using either Manfrotto half ball or Slide Kamera HSZ-2 quick mounting screw. There is also a possibility to mount accessories directly to the tripod crown using three M4 or M5 screws. Table below presents mounting configuration possibilities of Slide Kamera HST-3 tripod.

Mounting configuration possibilities of Slide Kamera HST-3 tripod

Mounting method	Mounting accessory	Dedicated device
Mounting to Slide Kamera HCZ socket	Manfrotto half ball Slide Kamera HSZ-2 quick mounting screw	Slide Kamera AKC-3 adapter Slide Kamera heads Slide Kamera AF-18 leveling adapter Slide Kamera HKR-1, HKR-2, HKR-6 camera cranes Slide Kamera S, SP, HSK series devices

Mounting directly to Slide Kamera HST-3 tripod crown

Three M6 screws
Three M5 screws

Slide Kamera AF-16 quick mounting adapter
Slide Kamera HKR-1, HKR-2, HKR-6 camera cranes
Slide Kamera heads
Slide Kamera AF-18 leveling adapter

Correct and detailed description on how to mount individual products on Slide Kamera HST-3 tripod can be found in User Manuals of these products.

In order to avoid any improper assembly or handling please refer to User Manuals of individual products before you mount them on Slide Kamera HST-3 tripod.

Slide Kamera HST-3 tripod comes with Slide Kamera HCZ 75mm or 100mm socket. Replaceable Slide Kamera HCZ sockets match systems such as Manfrotto, Sachtler, Miller. We are able to provide a socket for any type of video head on client's request. In order to mount devices directly on the tripod crown remove Slide Kamera HCZ socket using 3mm Allen key.

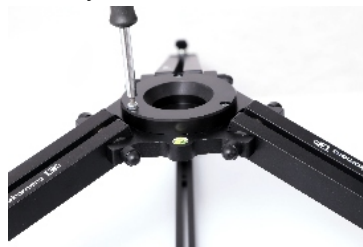

7. AF-24 adapter for mounting photo-video accessories on Slide Kamera HST series tripods

Adjustable Slide Kamera AF-24 adapter allows to mount additional photo-video accessories equipped with 1/4" or 3/8" thread on Slide Kamera HST series tripod, thus increasing the functionality of our tripod. Slide Kamera AF-24 adapter consists of a mounting plate, fixing plate and a clamping lever that connects the plates. Mounting plate is equipped with two hardened inserts with 3/8" holes and 1/4" hole. There are also two M6 holes for mounting the clamping lever in two positions (top or bottom).



Elements of Slide Kamera AF-24 adapter for mounting additional photo-video accessories

Clamping lever with M6 thread [1]

Fixing plate [2]

Mounting plate [3]

M6 thread [4]

M6 holes for mounting the lever [5]

1/4" threaded hole [6]

Hardened insert with 3/8" hole [7]

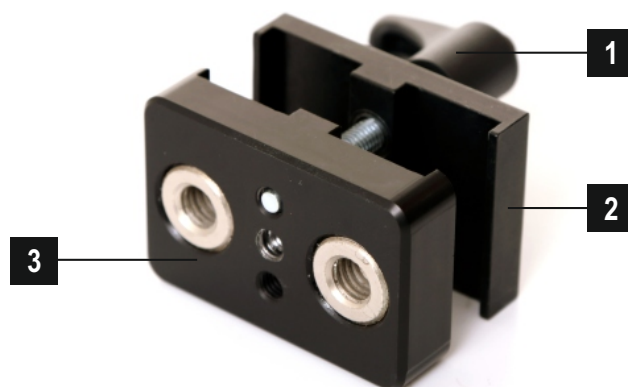

Mounting plate

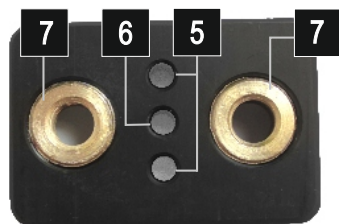

Fixing plate

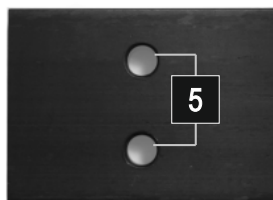

Clamping lever

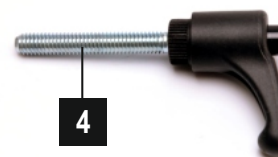

In order to mount AF-24 adapter on Slide Kamera HST series tripod attach the plates to tripod leg and connect them with a clamping lever. Adapter can be mounted either with a mounting plate facing the inside or outside of the tripod. Additionally AF-24 adapter can be mounted on the entire length of the tripod leg.



8. Maintenance

- ☑ By maintenance we understand cleaning the device
- ☑ Periodically tighten all screws to ensure maximum stability
- ☑ Elements of the tripod do not require any lubrication
- ☑ Do not overload
- ☑ Use a soft cloth to clean. Never use abrasive or caustic products, which could cause the damage of protective coatings
- ☑ To remove any impurities, you can use compressed air
- ☑ To clean the device you can use ear stick with cotton bud
- ☑ Transport and store your tripod in a dedicated Slide Kamera cover

**Any changes in design and repairs are made only and exclusively by the manufacturer.
Failure to comply with the recommended guidelines outlined in this manual
will result in loss of warranty.**

9. Transport

Slide Kamera manufacturer recommends to transport Slide Kamera HST-3 tripod in Slide Kamera PSK-8 cover that allows to carry the device safely, in any way so that it is protected against any damage. Cover dimensions allow to transport the tripod with video head or Slide Kamera head mounted, there is no need to remove it. Slide Kamera PSK-8 cover is made of waterproof polyester fabric of high durability, resistant to abrasion and weather conditions. It is equipped with inside straps that secure the tripod during transport.



10. Terms of warranty

All Slide Kamera products are covered manufacturer's warranty for a period of 12 months from the date of sale. Warranty covers any design faults or of the material of the product which resulted in the product malfunctioning. The warranty covers the repair, or, if the repair proves impossible, replacement of the product with a new one. However, the cost of repair of the product cannot overrun the catalogue value of the product. The warranty does not cover damage and / or product defects resulting from the improper usage, as well as not following product maintenance specifications.

The warranty excludes:

- unauthorized attempts to repair or modify
- mechanical damage caused during transport and operation of such features, scratches, dents, pits, dirt, etc ...
- flooding, moisture

To obtain warranty service the purchaser should deliver the damaged product together with a proof of purchase and proof of payment (invoice, cash register receipt). The product will be accepted for warranty service on condition that it is delivered with correctly filled in complaint form and properly protected during transport. You can download the complaint form from: www.slidekamera.pl / www.slidekamera.eu.

After the warranty period is exceeded any spare parts can be purchased directly from the manufacturer or in any selected points of sale.

PLEASE NOTE:

Any package sent at the expense of HET-CNC s.c., 80-175 Gdańsk, Ul. Kartuska 386 **will not be received.**

