

Manuals+

User Manuals Simplified.



Godox ML60 LED Light Instruction Manual

November 7, 2021 November 8, 2021

[Home](#) » [Godox](#) » Godox ML60 LED Light Instruction Manual 

Godox ML60 LED Light
Instruction Manual

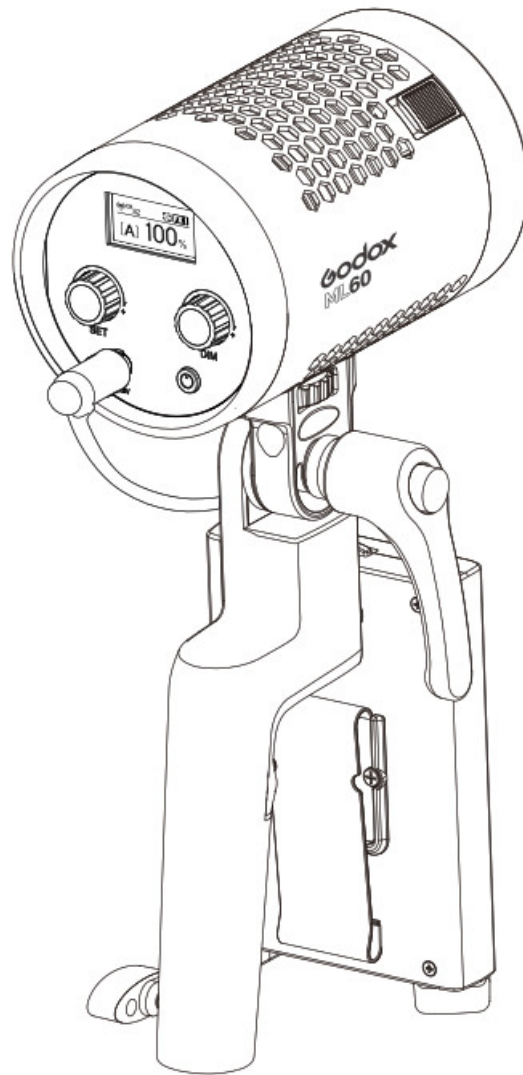

Contents [[hide](#)]

- [1 Foreword](#)
- [2 Parts](#)
- [3 What's in the Box](#)
- [4 Power Management](#)
- [5 Operation](#)
- [6 Technical Data](#)
- [7 Maintenance](#)
- [8 FCC Statement](#)
- [9 Documents / Resources](#)
 - [9.1 References](#)

Foreword





Thank you for purchasing this Godox Product! This LED Light ML60 is a continuous light with wireless adjustment and 8 FX situational special effects. Suitable for almost all shooting occasions e.g. live, camping, make up, portrait shooting, make up, video, wedding, children photography etc. It's portable and easy to be operated.

Features:

- Freely switch LED continuous light mode and 8 FX situational special effects modes
- 0% to 100% Precisely adjust light brightness
- 16 Groups and 32 channels wireless remote control
- Switch silent mode to light without interference

- Compact and lightweight, easy to be held in hand

 **Warning**

-  Always keep this product dry. Do not use in rain or in damp conditions.
-  Do not disassemble. Should repairs become necessary, this product must be sent to an authorized maintenance center.
-  Keep out of reach of children.
-  As this product do not have waterproof function, please take measures of waterproof in rainy or damp environment.
-  Do not use the flash unit in the presence of flammable gases, chemicals and other similar materials. In certain circumstance, these materials may be sensitive to the strong light emitting from this flash unit and fire or electromagnetic interference may result.

Parts

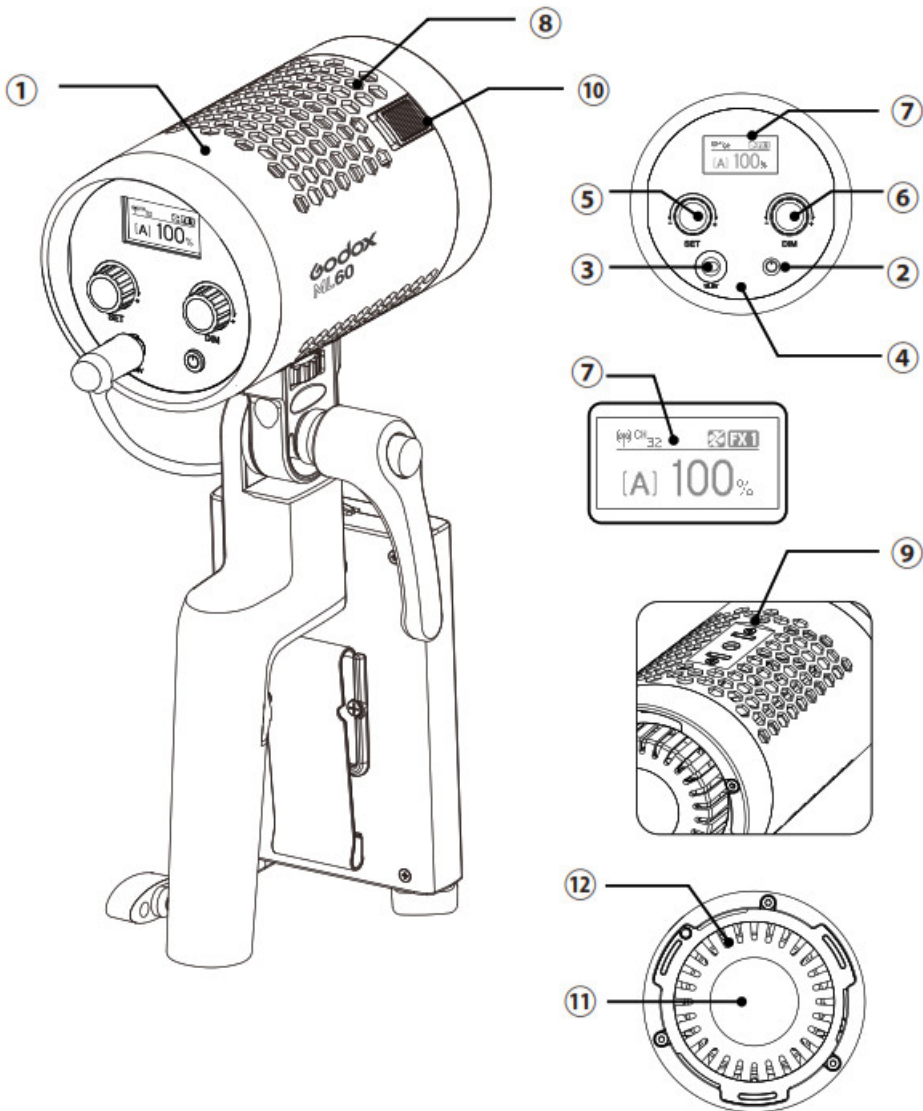

- 01. Body
- 02. Power Switch
- 03. DC Power Socket
- 04. Control Panel
- 05. SET Select Dial
- 06. DIM Select Dial
- 07. Display
- 08. Thermovent
- 09. Fixing Socket for Handle
- 10. Accessory Locking Ring
- 11. LED Light
- 12. Radiator

● **Handle**

- 13. Handle Bracket
- 14. Direction Adjusting Ring
- 15. Fixing Screw for Light Head
- 16. Fixing Screw for Light Stand

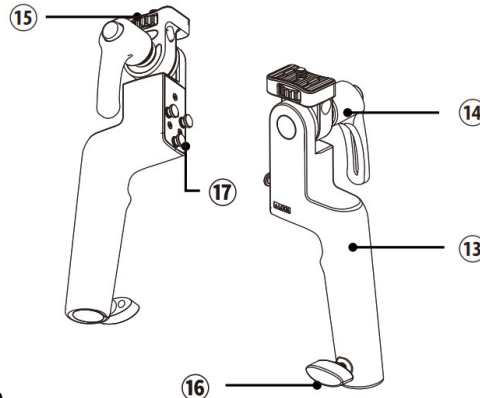

- 17. Fixing Buckle for Battery Case

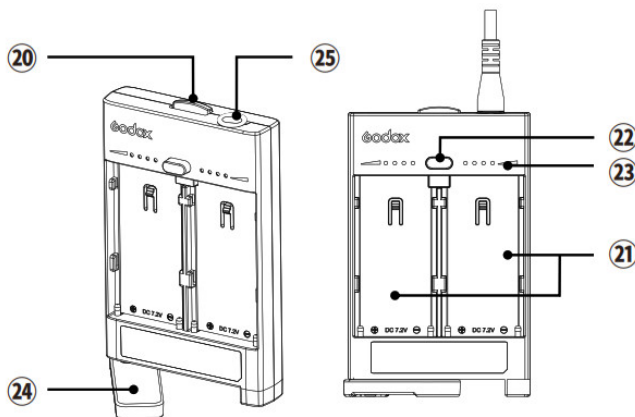
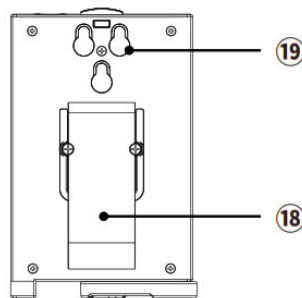

● **Battery Case**

- 18. Clip
- 19. Fixing Hole for Battery Case
- 20. Locking Ring for Battery Case
- 21. NP-F970 Battery Compartment 1 and 2
- 22. Battery Level Display Button/Battery Locking Ring
- 23. Battery Level Indicator
- 24. Battery Case Leg
- 25. Battery Power Output Port

What's in the Box

Light Body ML60
*1

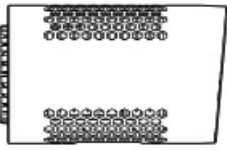

Handle *1



Battery Case
BC60 *1

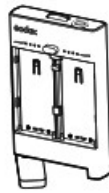

Adapter *1



Adapter Holder *1



Reflector *1

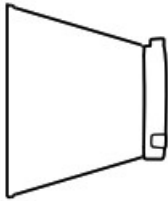

Protect Cover *1

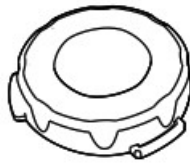

5m AC Power Cable
*1



1.5m DC Power Cable
*1



0.2m DC Power Cable *1



Fastener *1
Clip *1



Portable Bag *1



Instruction Manual *1



Power Management

1. Power Supply

Adapter power supply: input: 100-240V~50/60Hz 2A, output: 16.8V 4.2A.

External battery power supply: install two NP-F970 batteries into the battery compartment. Then, use the power cable to connect the battery case with the light body to achieve a power supply.

The battery case can only offer battery discharging instead of charging. When powered by a battery box, two batteries shall be used simultaneously. Please do not use one battery individually.

Operation

1. Power On

Press the power switch to control the on/off of the light, and the OLED display will show the current information.

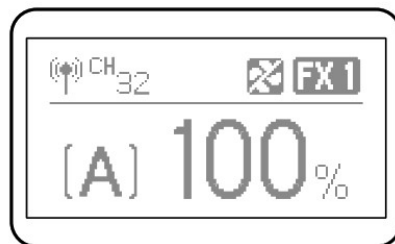
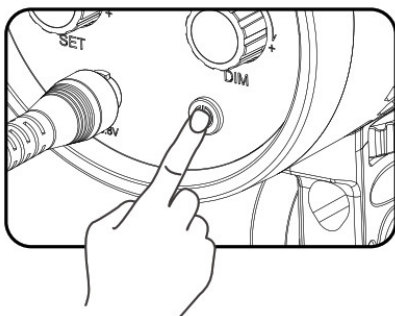

2. Mode Selection: Continuous Lighting Mode/FX Special Effects Mode

Press SET button to enter the menu. Then, turn the SET select dial to FX and screw the DIM select dial to switch the two modes:

Continuous lighting mode: set FX mode to OFF to enter continuous lighting mode.
 Special effects mode: there are 8 situational special effects from FX1 to FX8.

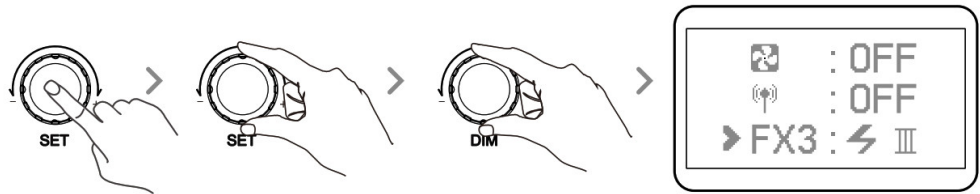

Special Effects	FX1	FX2	FX3	FX4	FX5	FX6	FX7	FX8
Icon	⚡ I	⚡ II	⚡ III	⚡+I	⚡+II	⚡+III	TV	💡
Situation	Lightning intervals	Lightning frequent	Lightning sustainable	Flash	Conference	Paparazzi	TV	Broken bulb

3. 2.4G Wireless Setting

Turn on/off 2.4G wireless: press SET button to enter the menu. Turn the SET select dial until the wireless icon is displayed. Then, turn the DIM select dial to turn on or off 2.4G wireless.

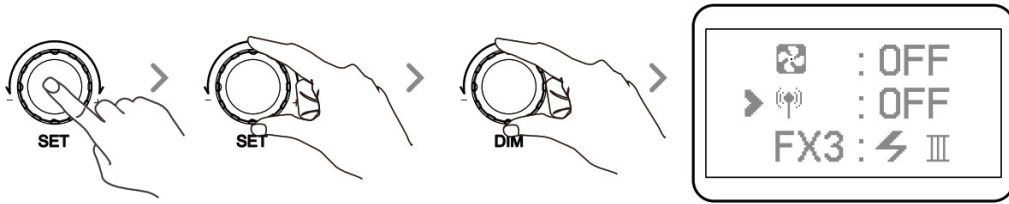

Channel CH setting:

press SET button to enter the menu. Turn the SET select dial until the CH is displayed. Then, turn the DIM select dial to choose channel from 1 to 32.

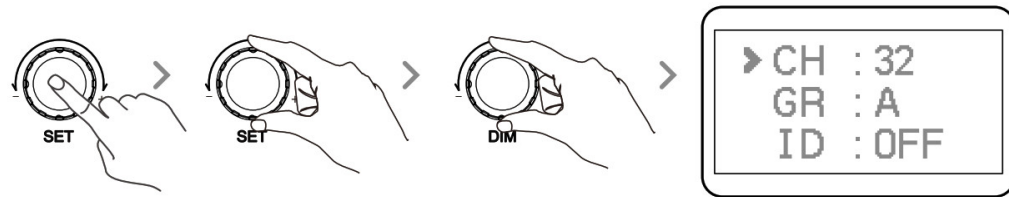

Group GR setting:

press SET button to enter the menu. Turn the SET select dial until the GR is displayed. Then, turn the DIM select dial to choose group from A to E and 0 to 9.

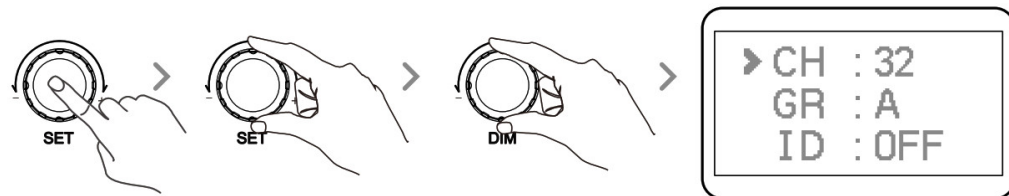

ID setting:

press SET button to enter the menu. Turn the SET select dial until the ID is displayed. Then, turn the DIM select dial to choose 99 IDs from 1 to 99.

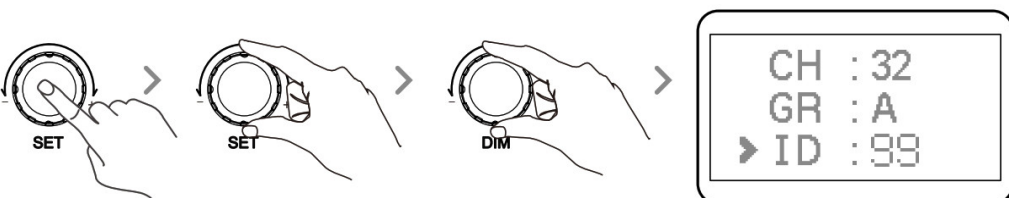

4. Brightness adjustment:

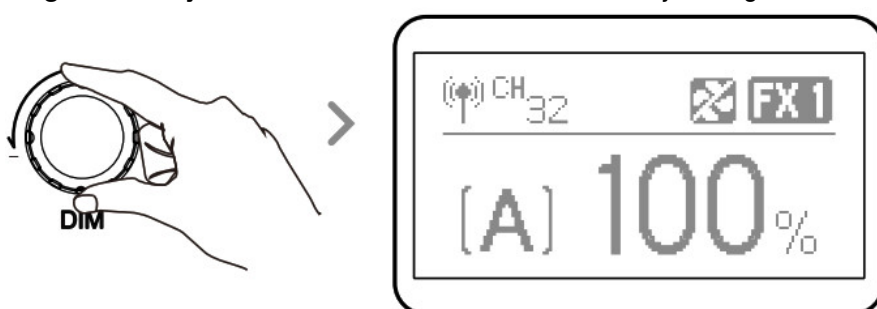

5. Silent mode:

when  is displayed, the silent mode is turned on.

Turn on the silent mode: press SET button to enter the menu. Then, screw the DIM select dial to turn on or off the silent mode. Set it to on to enter non-silent mode while set it to off to enter silent mode.

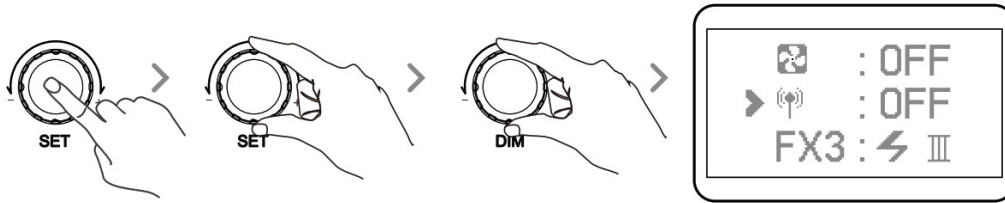

6. Install and detach battery case

6.1 Install battery case: Aim the handle's fixing buckles into the battery case's fixing holes, pull the battery case downwards until being tightened.

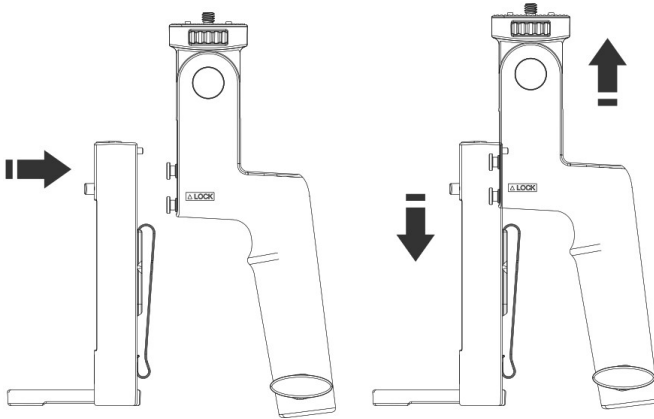

6.2 Detach battery case: push the battery case' locking ring and push the battery case upwards to take it out.

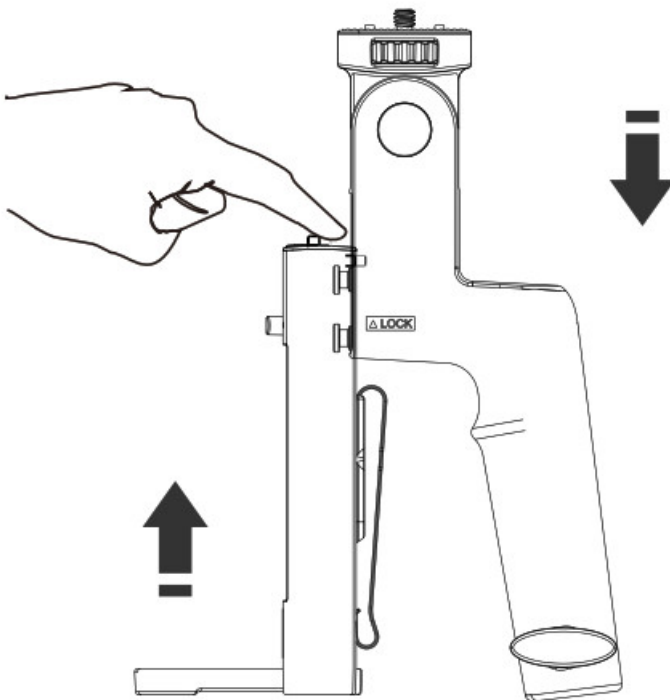

6.3 Connect the battery case with light head: insert the one end with clamping buckle of the power cable into the battery case while another end into the DC power socket of the light head.

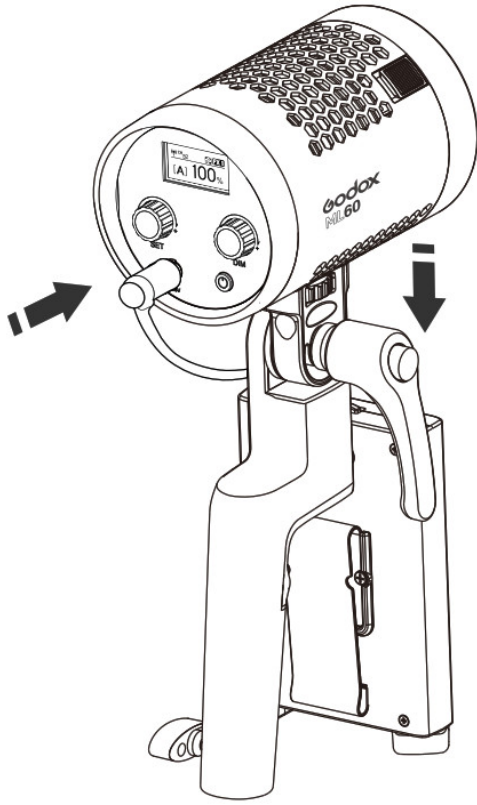

6.4 Insert two FP970 batteries, and the LED light can be put into usage.

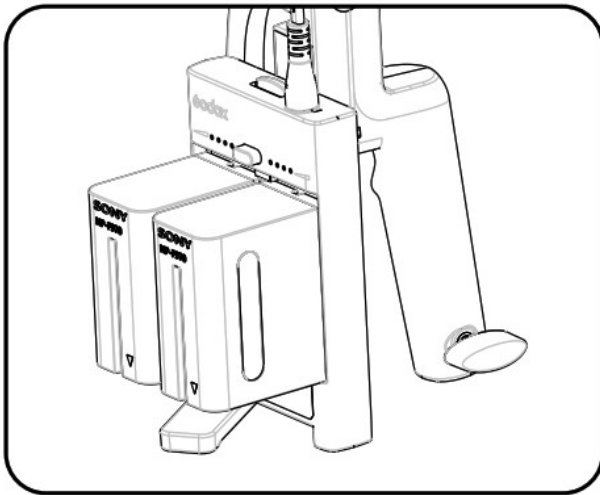

Technical Data

LED Light	ML60
Adapter	Output: 16.8V 4.2A
Power	Max. 60W
Channel	32
Group	16(A B C D E F,0-9)
Brightness Adjusting Range	0%~100%
100% Illuminance(LUX)(≈)	73000 (testing distance is 0.5m)
CRI(≈)	96
TLCI(≈)	97
Color Temperature	5600 ± 200K
Working Temperature	-10~40°C
Weight	0.77Kg (not include handle and reflector)
Dimension	145*88*88mm (not include handle and reflector)

* Product design and specifications are subject to change without notice.

Maintenance

This product, except consumables e.g. charger and charger cable, is supported with a one-year warranty. Avoid sudden impacts and the product should be dedusted regularly. Maintenance of the flash must be performed by our authorized maintenance department which can provide original accessories. Unauthorized service will void the warranty. If the product had failures or was wetted, do not use it until it is repaired by professionals. Changes made to the specifications or designs may not be reflected in this manual.

FCC Statement

This device complies with part 15 of the FCC Rules. Operation is subject to the following two conditions: (1) This device may not cause harmful interference, and (2) this device must accept any interference received, including interference that may cause undesired operation.

Any Changes or modifications not expressly approved by the party responsible for compliance could void the user's authority to operate the equipment.

Note: This equipment has been tested and found to comply with the limits for a Class B digital device, pursuant to part 15 of the FCC Rules. These limits are designed to provide reasonable protection against harmful interference in a residential installation. This equipment generates uses and can radiate radio frequency energy and, if not installed and used in accordance with the instructions, may cause harmful interference to radio communications. However, there is no guarantee that interference will not occur in a particular installation. If this equipment does cause harmful interference to radio or television reception, which can be determined by turning the equipment off and on, the user is encouraged to try to correct the interference by one or more of the following measures:

- Reorient or relocate the receiving antenna.
- Increase the separation between the equipment and receiver.
- Connect the equipment into an outlet on a circuit different from that to which the receiver is connected.
- Consult the dealer or an experienced radio/TV technician for help.

GODOX Photo Equipment Co., Ltd.

Add: Building 2, Yaochuan Industrial Zone, Tangwei Community, Fuhai Street, Bao'an District, Shenzhen, China Tel: +86-755-29609320(8062) Fax: +86-755-25723423 E-mail: godox@godox.com
godox.com



Made in China

Documents / Resources



[Godox ML60 LED Light](#) [pdf] Instruction Manual
ML60, LED Light

References

- [GODOX PHOTO EQUIPMENT CO.,LTD](#)

Manuals+,

- [home](#)
- [privacy](#)

