





## A. Adjusting the flange focal distance to the lens

---

Congratulations on the purchase of this Compact Prime CP.2 or Compact Zoom CZ.2 lens set. We are convinced that your new lenses will bring you much pleasure and success.

The Compact Prime CP.2 lenses and the Compact Zoom CZ.2 lenses are the latest members of the ZEISS family of lenses for digital and film cameras. They deliver great flexibility by introducing interchangeable mounts that allow the lenses to be used with a wide range of cameras, from traditional cine to HDSLR systems. Available in five different mounts – PL, EF, F, Micro 4/3 and E – this new family of ZEISS lenses enables cinematographers to be completely free in their choice of camera systems. The Compact Prime CP.2 and Compact Zoom CZ.2 lenses cover the full-frame image format without vignetting.

In this manual we take a Compact Prime CP.2 35mm/ T 2.1 with EF mount, scaled in feet as an example to explain how to change a lens mount and the subsequent matching of your lens to a DSLR camera. Proceed in the same sequences to switch to any other CP.2 or CZ.2 mount.



## B. Overview

---

### General instructions

- The use of a T6 torque wrench with a torque of 0.4 Nm is strongly recommended. This wrench can be purchased from ZEISS (see appendix, page 17).
  - Ensure that the environment is clean and free from dust so that no dust particles can enter the lens during the following procedure.
  - Smudges and fingerprints on the lens surface can be gently removed with a soft brush and then with a dry and clean cotton cloth. The ZEISS lens cleaning kit will give superior results and is highly recommended for this purpose.
  - When matching the lens, ensure that the colored shims lie on top of each other in the groove of the lens barrel and do not cover the screw holes.
  - Please handle the shims carefully as they can easily kink or tear which makes them unusable.
- 



*EF mount*

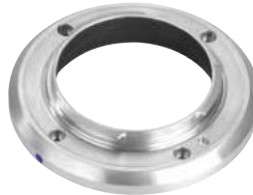

*Micro 4/3 mount*



*PL mount*



*F mount*



*E mount*

---

## General drawing

- 1** Lens
- 2** Groove of the lens barrel
- 3** Shim
- 4** Adapter ring with attached silver support bracket
- 5** Mount including threaded black inner ring (e.g. EF)
- 6** Torx screws

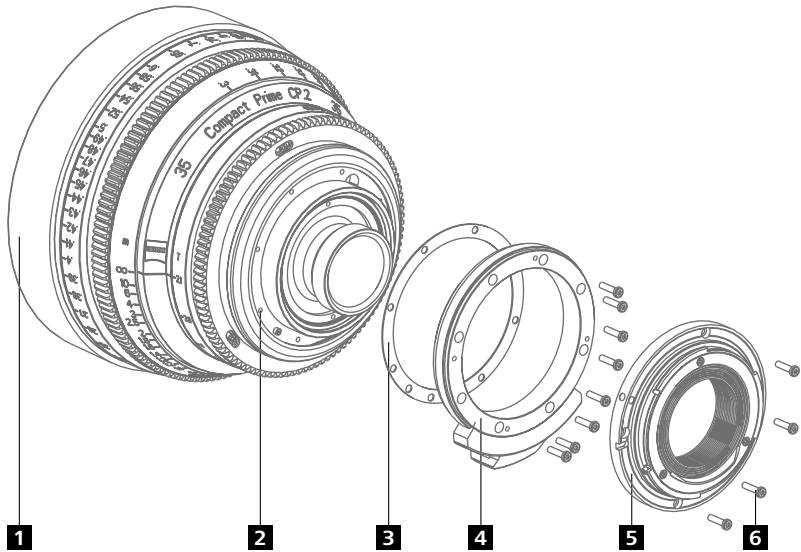

Learn how to change the mount of ZEISS Compact Prime CP.2 and ZEISS Compact Zoom CZ.2:

<https://www.youtube.com/watch?v=NJTewQ-V3rM&feature=youtu.be>

## C. Changing the mount

---

1. Remove the rear lens cap.



2. Remove the four torx screws of the silver EF mount with a T6 torque wrench and place the mount and the screws on one side.

The size of the black inner ring depends on the focal length of the lens and is securely fastened to the EF mount (or F, MFT or E Mount) at the factory.



3. Remove the eight torx screws of the black EF adapter ring and place the ring and the screws on one side.

The silver support bracket is already installed on the EF adapter ring at the factory and does not need to be removed.



---

**4.** Now you see the colored shims in the groove of the black lens barrel.



---

**5.** Place the PL mount on the lens in such a way that the groove on the rear side of the PL mount fits over the silver screw on the lens barrel.

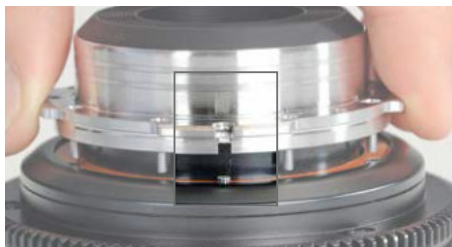

---

**6.** Tighten the eight torx screws with the T6 torque wrench using a torque of 0.4 Nm.



---

**7.** When the torx screws have been tightened, the lens can be fitted to a camera with a PL mount and used.

---

**8.** Check the flange focal distance of the lens (see section D) in combination with your camera screw of the lens barrel.

---



---

## Instructions on changing to an EF or to any other CP.2 or CZ.2 mount

---

1. Ensure that the groove on the rear side of the black EF adapter ring fits over the small screw of the lens barrel.

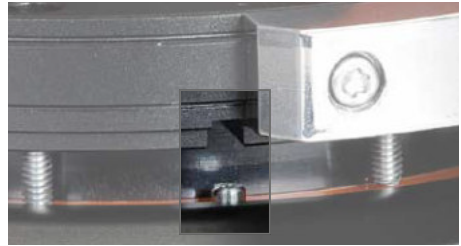

2. Place the silver EF mount on the EF adapter ring in such a way that the blue dot on the mount has the same orientation as the ZEISS logo and the support bracket points to the serial number on the lens barrel.



3. Please note the correct orientation of the F mount to the ZEISS logo.





---

**4.** Please note the correct orientation of the Micro 4/3 and the E mount to the serial number on the lens barrel.



---

**5.** Tighten the torx screws using a torque of 0.4 Nm.



## D. Adjusting the lens to your camera

---

As the flange focal distance varies from camera type to camera type, it is necessary to adjust the CP.2 or CZ.2 lens to the camera used when changing the mount or camera model (=shimming). In order to perform this adjustment, ZEISS provides shims in different thicknesses that are color coded.

When the mount has been unscrewed, these shims can be placed in a groove in the lens barrel. Any possible combination of shims can be used to achieve the required thickness and therefore the required flange focal distance. The lens already contains shims when delivered.

ZEISS recommends that the camera is set to the usual standard settings (cf. works settings). You can obtain further details from the instruction manual of the camera you use.

---

### Procedure

In the following chapter we explain how to adjust your Compact Prime CP.2 or CZ.2 to a DSLR camera.

---

**1.** Fasten the ZEISS test chart on a wall at the appropriate test distance (see tables on page 12 – 16; the test distance is depending on the focal length) and ensure that the illumination is bright and uniform.

---

**2.** Mount the camera and lens on a tripod and level the camera, making sure that the centre of the image is aligned with the centre of the Siemens star.

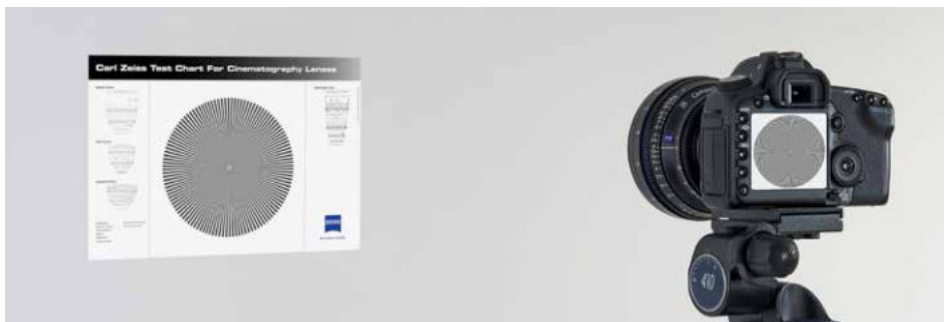

**3.** Activate the live view of your camera, select the maximum magnification.

---

---

**4.** Set the distance ring to the test distance according to the tables in the appendix. This setting must not be changed during the adjustment process.

---

**5.** Set the aperture of the lens to full speed.

---

**6.** Obtain maximum image sharpness on the live view by varying the distance between the test chart and the camera.

---

**7.** Now remeasure the distance between the image plane mark on the camera body and the test chart (= the actual distance).



---

**8.** If the distance has changed, the flange focal distance of the lens must be adjusted by using the colored shims.

You find a list of tables in the appendix for each focal length to calculate the resultant change of the flange focal distance.

---

**9.** Now remove the lens from the camera.



---

**10.** Remove the EF mount and EF adapter ring (cf. section C 2–4).

---

---

**11.** Determine the total thickness of the shims that are already installed in the lens groove. Increase or decrease the total shim thickness according to the tables in the appendix by using a flat-bladed screw-driver or a pair of tweezers.



---

**12.** Place the black EF adapter ring on the lens barrel and tighten the screws using a torque of 0.4 Nm.



---

**13.** The next step is to place the silver EF mount on the EF adapter ring and tighten the screws using a torque of 0.4 Nm.













---

**14.** Recheck the flange focal distance of the lens (see section D) in combination with the camera you use.

---

# E. Appendix

**Table for shims to adjust Compact Prime CP.2 or Compact Zoom CZ.2 lenses when used on digital cameras**

Shim color	Thickness [mm]	
silver	0.013	
gold	0.019	
purple	0.025	
light blue	0.032	
red	0.038	
blue	0.051	
white	0.064	
green	0.076	
orange	0.102	
light purple	0.127	
clear	0.152	

### Example

Using a Compact Prime CP.2 35mm/T2.1 lens with an EF mount, scaled in feet and a test chart at a test distance of 4 ft, an actual distance of 4 ft 1' is measured. Due to the table on page 14, a silver shim 0.013 mm must therefore be added to the total thickness of the shims.

### Note

Any combination of shims is possible to achieve the required thickness and therefore the desired flange focal distance. Always use the closest possible combination of shims.

### Tables for adjusting the flange focal distance of Compact Prime CP.2 or an Compact Zoom CZ.2 lenses

All Compact Prime CP.2 and Compact Zoom CZ.2 lenses cover the full-frame image format (36 x 24 mm), an ANSI Super 35 and Normal 35 image format, except the CP.2 18mm/T3.6. This lens covers the APS-H image format.

### Key

**Minus sign:** Shims must be removed

**Plus sign:** Shims must be added

---

## Compact Prime CP.2 15/T2.9

### Meter distance scale

Distance to test chart [mm] 1000

### Feet distance scale

Distance to test chart [ft] 4

<b>Object distance at best focus [mm]</b>	<b>Change of total washer thickness [mm]</b>	<b>Object distance at best focus [ft]</b>	<b>Change of total washer thickness [mm]</b>
860	-0,04	3ft 4'	-0,04
895	-0,03	3ft 6'	-0,03
930	-0,02	3ft 8'	-0,02
965	-0,01	3ft 10'	-0,01
1000	0,00	4ft 0'	0,00
1035	0,01	4ft 2'	0,01
1070	0,02	4ft 4'	0,02
1105	0,03	4ft 6'	0,03
1140	0,04	4ft 8'	0,04

---

## Compact Prime CP.2 18/T3.6

### Meter distance scale

Distance to test chart [mm] 1000

### Feet distance scale

Distance to test chart [ft] 4

<b>Object distance at best focus [mm]</b>	<b>Change of total washer thickness [mm]</b>	<b>Object distance at best focus [ft]</b>	<b>Change of total washer thickness [mm]</b>
900	-0,04	3ft 8'	-0,03
925	-0,03	3ft 9'	-0,02
950	-0,02	3ft 10'	-0,01
975	-0,01	3ft 11'	-0,01
1000	0,00	4ft 0'	0,00
1025	0,01	4ft 1'	0,01
1050	0,02	4ft 2'	0,01
1075	0,03	4ft 3'	0,02
1100	0,04	4ft 4'	0,03

---

## Compact Prime CP.2 21/T2.9

Meter distance scale		Feet distance scale	
Distance to test chart [mm]	1000	Distance to test chart [ft]	4
Object distance at best focus [mm]	Change of total washer thickness [mm]	Object distance at best focus [ft]	Change of total washer thickness [mm]
940	-0,04	3ft 8'	-0,04
955	-0,03	3ft 9'	-0,03
970	-0,02	3ft 10'	-0,02
985	-0,01	3ft 11'	-0,01
1000	0,00	4ft 0'	0,00
1015	0,01	4ft 1'	0,01
1030	0,02	4ft 2'	0,02
1045	0,03	4ft 3'	0,03
1060	0,04	4ft 4'	0,04

---

## Compact Prime CP.2 25/T2.9 and CP.2 25/T2.1

Meter distance scale		Feet distance scale	
Distance to test chart [mm]	1000	Distance to test chart [ft]	4
Object distance at best focus [mm]	Change of total washer thickness [mm]	Object distance at best focus [ft]	Change of total washer thickness [mm]
960	-0,03	3ft 8'	-0,05
970	-0,02	3ft 9'	-0,04
980	-0,02	3ft 10'	-0,03
990	-0,01	3ft 11'	-0,01
1000	0,00	4ft 0'	0,00
1010	0,01	4ft 1'	0,01
1020	0,02	4ft 2'	0,03
1030	0,02	4ft 3'	0,04
1040	0,03	4ft 4'	0,05



---

## Compact Prime CP.2 28/T2.1

Meter distance scale		Feet distance scale	
Distance to test chart [mm]	1000	Distance to test chart [ft]	4
Object distance at best focus [mm]	Change of total washer thickness [mm]	Object distance at best focus [ft]	Change of total washer thickness [mm]
960	-0,04	3ft 10'	-0,03
970	-0,03	3ft 10 1/2'	-0,03
980	-0,02	3ft 11'	-0,02
990	-0,01	3ft 11 1/2'	-0,01
1000	0,00	4ft 0'	0,00
1010	0,01	4ft 1'	0,01
1020	0,02	4ft 1 1/2'	0,02
1030	0,03	4ft 2'	0,03
1040	0,04	4ft 2 1/2'	0,03

---

## Compact Prime CP.2 35/T2.1 and CP.2 35/T1.5 Super Speed

Meter distance scale		Feet distance scale	
Distance to test chart [mm]	1000	Distance to test chart [ft]	4
Object distance at best focus [mm]	Change of total washer thickness [mm]	Object distance at best focus [ft]	Change of total washer thickness [mm]
980	-0,03	3ft 10'	-0,05
985	-0,02	3ft 10 1/2'	-0,04
990	-0,02	3ft 11'	-0,03
995	-0,01	3ft 11 1/2'	-0,01
1000	0,00	4ft 0'	0,00
1005	0,01	4ft 1'	0,01
1010	0,02	4ft 1 1/2'	0,03
1015	0,02	4ft 2'	0,04
1020	0,03	4ft 2 1/2'	0,05

---

## Compact Prime CP.2 50/T2.1, CP.2 50/T2.1 Macro and CP.2 50/T1.5 Super Speed

Meter distance scale		Feet distance scale	
Distance to test chart [mm]	1500	Distance to test chart [ft]	5
Object distance at best focus [mm]	Change of total washer thickness [mm]	Object distance at best focus [ft]	Change of total washer thickness [mm]
1480	-0,03	4ft 11'	-0,03
1485	-0,02	4ft 11 1/4'	-0,03
1490	-0,01	4ft 11 1/2'	-0,02
1495	-0,01	4ft 11 3/4'	-0,01
1500	0,00	5ft 0'	0,00
1505	0,01	5ft 1/4'	0,01
1510	0,01	5ft 1/2'	0,02
1515	0,02	5ft 3/4'	0,03
1520	0,03	5ft 1'	0,03

---

## Compact Prime CP.2 85/T2.1 and CP.2 85/T1.5 Super Speed

Meter distance scale		Feet distance scale	
Distance to test chart [mm]	1500	Distance to test chart [ft]	5
Object distance at best focus [mm]	Change of total washer thickness [mm]	Object distance at best focus [ft]	Change of total washer thickness [mm]
1492	-0,03	4ft 11 4/8'	-0,05
1494	-0,02	4ft 11 5/8'	-0,04
1496	-0,02	4ft 11 6/8'	-0,02
1498	-0,01	4ft 11 7/8'	-0,01
1500	0,00	5ft 0'	0,00
1502	0,01	5ft 1/8'	0,01
1504	0,02	5ft 2/8"	0,02
1506	0,02	5ft 3/8'	0,04
1508	0,03	5ft 4/8'	0,05

---

## Compact Prime CP.2 100/T2.1 CF

### Meter distance scale

Distance to test chart [mm] 2000

### Feet distance scale

Distance to test chart [ft] 7

<b>Object distance at best focus [mm]</b>	<b>Change of total washer thickness [mm]</b>	<b>Object distance at best focus [ft]</b>	<b>Change of total washer thickness [mm]</b>
1987	-0,04	6ft 11 4/8'	-0,03
1990	-0,03	6ft 11 5/8'	-0,02
1993	-0,02	6ft 11 6/8'	-0,02
1997	-0,01	6ft 11 7/8'	-0,01
2000	0,00	7ft 0'	0,00
2003	0,01	7ft 1/8'	0,01
2007	0,02	7ft 2/8'	0,02
2010	0,03	7ft 3/8'	0,03
2013	0,04	7ft 4/8'	0,03

---

## Compact Prime CP.2 135/T2.1

### Meter distance scale

Distance to test chart [mm] 2000

### Feet distance scale

Distance to test chart [ft] 7

<b>Object distance at best focus [mm]</b>	<b>Change of total washer thickness [mm]</b>	<b>Object distance at best focus [ft]</b>	<b>Change of total washer thickness [mm]</b>
1992	-0,05	6ft 11 4/8'	-0,06
1994	-0,03	6ft 11 5/8'	-0,05
1996	-0,02	6ft 11 6/8'	-0,03
1998	-0,01	6ft 11 7/8'	-0,02
2000	0,00	7ft 0'	0,00
2002	0,01	7ft 1/8'	0,02
2004	0,02	7ft 2/8'	0,03
2006	0,03	7ft 3/8'	0,05
2008	0,05	7ft 4/8'	0,06

---

## Compact Zoom CZ.2 70–200/T2.9

Meter distance scale		Feet distance scale	
Distance to test chart [mm]	4500	Distance to test chart [ft]	15
Object distance at best focus [mm]	Change of total washer thickness [mm]	Object distance at best focus [ft]	Change of total washer thickness [mm]
4460	-0,09	14ft 10'	-0,11
4470	-0,07	14ft 10 1/2'	-0,08
4480	-0,04	14ft 11'	-0,06
4490	-0,02	14ft 11 1/2'	-0,03
4500	0,00	15ft 0'	0,00
4510	0,02	15ft 1/2'	0,03
4520	0,04	15ft 1'	0,06
4530	0,07	15ft 1 1/2'	0,08
4540	0,09	15ft 2'	0,11

---

## Compact Zoom CZ.2 28–80/T2.9

Meter distance scale		Feet distance scale	
Distance to test chart [mm]	2000	Distance to test chart [ft]	7
Object distance at best focus [mm]	Change of total washer thickness [mm]	Object distance at best focus [ft]	Change of total washer thickness [mm]
1960	-0,07	7ft 10'	-0,10
1970	-0,06	7ft 10 1/2'	-0,07
1980	-0,04	7ft 11'	-0,05
1990	-0,02	7ft 11 1/2'	-0,02
2000	0,00	7ft 0'	0,00
2010	0,02	7ft 1/2'	0,02
2020	0,04	7ft 1'	0,05
2030	0,06	7ft 1 1/2'	0,07
2040	0,07	7ft 2'	0,10

---

## Compact Zoom CZ.2 15–30/T2.9

### Meter distance scale

Distance to test chart [mm] 1000

Object distance at best focus [mm]	Change of total washer thickness [mm]
------------------------------------	---------------------------------------

960	-0,06
-----	-------

970	-0,04
-----	-------

980	-0,03
-----	-------

990	-0,01
-----	-------

1000	0,00
------	------

1010	0,01
------	------

1020	0,03
------	------

1030	0,04
------	------

1040	0,06
------	------

### Feet distance scale

Distance to test chart [ft] 4

Object distance at best focus [ft]	Change of total washer thickness [mm]
------------------------------------	---------------------------------------

3ft 10'	-0,04
---------	-------

3ft 10 1/2'	-0,03
-------------	-------

3ft 11'	-0,02
---------	-------

3ft 11 1/2'	-0,01
-------------	-------

4ft 0'	0,00
--------	------

4ft 1'	0,01
--------	------

4ft 1 1/2'	0,02
------------	------

4ft 2'	0,03
--------	------

4ft 2 1/2'	0,04
------------	------



---

## Compact Prime and Zoom lenses – Accessories and spare parts

All interchangeable mount sets include: mount, lens caps, adaption ring with support bracket, screws and a set of shims CP.2 and CZ.2.

<b>EF mount</b>	<b>Indent No.</b>
Interchangeable Mount Set EF (for CP.2 18/T3.6)	1846-490
Interchangeable Mount Set EF (for CP.2 21/T2.9, CP.2 25/T2.1, CP.2 28/T2.1 or CP.2 35/T2.1)	1846-492
Interchangeable Mount Set EF (for CP.2 15/T2.9, CP.2 35/T1.5 SuSp, CP.2 50/T1.5 SuSp, CP.2 50/T2.1, CP.2 85/T1.5 SuSp or CP.2 85/T2.1)	1846-494
Interchangeable Mount Set EF (for CP.2 50/T2.1 Macro)	1846-496
Interchangeable Mount Set EF (for CP.2 100/T2.1 CF)	1846-499
Interchangeable Mount Set EF (CP.2 135/T2.1)	1998-731
Interchangeable Mount Set EF (CZ.2 70-200/T2.9)	2002-824
Interchangeable Mount Set EF (CZ.2 28-80/T2.9)	2016-087
Interchangeable Mount Set EF (CZ.2 15-30/T2.9)	2075-923
<b>PL mount</b>	
Interchangeable Mount Set PL (for CP.2 18/T3.6)	1846-489
Interchangeable Mount Set PL (for CP.2 21/T2.9, CP.2 25/T2.1, CP.2 28/T2.1 or CP.2 35/T2.1)	1846-491
Interchangeable Mount Set PL (for CP.2 15/T2.9, CP.2 35/T1.5 SuSp, CP.2 50/T1.5 SuSp, CP.2 50/T2.1, CP.2 85/T1.5 SuSp or CP.2 85/T2.1)	1846-493
Interchangeable Mount Set PL (for CP.2 50/T2.1 Macro)	1846-495
Interchangeable Mount Set PL (for CP.2 100/T2.1 CF)	1846-498
Interchangeable Mount Set PL (CP.2 135/T2.1)	1998-730
Interchangeable Mount Set PL (CZ.2 70-200/T2.9)	2002-823
Interchangeable Mount Set PL (CZ.2 28-80/T2.9)	2016-086
Interchangeable Mount Set PL (CZ.2 15-30/T2.9)	2075-926

<b>F mount</b>	<b>Indent No.</b>
Interchangeable Mount Set F (for CP.2 15/T2.9)	1998-736
Interchangeable Mount Set F (for CP.2 18/T3.6)	1871-042
Interchangeable Mount Set F (for CP.2 21/T2.9, CP.2 25/T2.1, CP.2 28/T2.1 or CP.2 35/T2.1)	1871-043
Interchangeable Mount Set F (for CP.2 35/T1.5 SuSp, CP.2 50/T1.5 SuSp, CP.2 50/T2.1, CP.2 50/T2.1 Macro, CP.2 85/T1.5 SuSp or CP.2 85/T.2.1)	1871-046
Interchangeable Mount Set F (for CP.2 100/T2.1 CF)	1871-044
Interchangeable Mount Set F (CP.2 135/T2.1)	1998-732
Interchangeable Mount Set F (CZ.2 70-200/T2.9)	2002-825
Interchangeable Mount Set F (CZ.2 28-80/T2.9)	2016-448
Interchangeable Mount Set F (CZ.2 15-30/T2.9)	2075-924
<b>Micro 4/3 mount</b>	
Interchangeable Mount Set MFT (for CP.2 18/T3.6)	1889-230
Interchangeable Mount Set MFT (for CP.2 21/T2.9, CP.2 25/T2.1, CP.2 28/T2.1 or CP.2 35/T2.1)	1889-231
Interchangeable Mount Set MFT (for CP.2 15/T2.9, CP.2 35/T1.5 SuSp, CP.2 50/T1.5 SuSp, CP.2 50/T2.1, CP.2 85/T1.5 SuSp or CP.2 85/T.2.1)	1889-232
Interchangeable Mount Set MFT (for CP.2 50/T2.1 Macro)	1889-233
Interchangeable Mount Set MFT (for CP.2 100/T2.1 CF)	1889-234
Interchangeable Mount Set MFT (for CP.2 135/T2.1)	1998-733
Interchangeable Mount Set MFT (CZ.2 70-200/T2.9)	2002-826
Interchangeable Mount Set MFT (CZ.2 28-80/T2.9)	2016-449
Interchangeable Mount Set MFT (CZ.2 15-30/T2.9)	2075-925
<b>E mount</b>	
Interchangeable Mount Set E (for CP.2 18/T3.6)	1907-608
Interchangeable Mount Set E (for CP.2 21/T2.9, CP.2 25/T2.1, CP.2 28/T2.1 or CP.2 35/T2.1)	1907-609
Interchangeable Mount Set E (for CP.2 15/T2.9, CP.2 35/T1.5 SuSp, CP.2 50/T1.5 SuSp, CP.2 50/T2.1, CP.2 85/T1.5 SuSp or CP.2 85/T.2.1)	1907-610
Interchangeable Mount Set E (for CP.2 50/T2.1 Macro)	1907-611
Interchangeable Mount Set E (for CP.2 100/T2.1 CF)	1907-612
Interchangeable Mount Set E (for CP.2 135/T2.1)	1998-735
Interchangeable Mount Set E (CZ.2 70-200/T2.9)	2002-827
Interchangeable Mount Set E (CZ.2 28-80/T2.9)	2016-450
Interchangeable Mount Set E (CZ.2 15-30/T2.9)	2075-922



<b>ZEISS Diopters</b>	<b>Indent No.</b>
Diopter +0,5 (meter/feet)	1430-420
Diopter +1,0 (meter/feet)	1430-399
Diopter +2,0 (meter/feet)	1430-309
<b>Accessories</b>	
Support Bracket EF, F, MFT, E (incl. screws)	1856-667
Torx torque wrench (T6, torque moment 0.4 Nm)	0520-065
Torx Pan-Head screw (M2 x 8 -SUS 410; 50 pcs.)	500-022
Front Lens Cap Focal Lengths 18–85mm & 100mm CF	0097-227
Front Lens Cap Focal Length 50mm Macro	1775-836
Rear Lens Cap EF	1793-167
Rear Lens Cap PL	102160-0052-000
Rear Lens Cap F	1793-178
Rear Lens Cap MFT	1889-118
Rear Lens Cap E	1907-145
Siemens Star test chart (DIN A3, laminated)	1849-755
Set of shims CP,2	1853-634

**Carl Zeiss AG**  
Camera Lenses  
73446 Oberkochen  
Germany

Phone +49 7364 20-6175  
Fax: +49 7364 20-4045

[www.zeiss.com/cine](http://www.zeiss.com/cine)