



## ZEISS Lightweight Zoom LWZ.3

Mount Change Instructions



# Table of Contents

<b>Introduction</b>	<b>3</b>
<hr/>	
Explanation of Symbols	3
Overview	4
Delivery Contents of a ZEISS LWZ.3	4
Technical Data	5
<b>Changing the Mount of a ZEISS LWZ.3</b>	<b>6</b>
<hr/>	
Detaching a Mount	6
Attaching a Mount	10
<b>Adjusting a ZEISS LWZ.3 to Your Digital Camera</b>	<b>15</b>
<hr/>	
Testing the Sharpness	16
Correcting the Flange Focal Distance	19
<b>Appendix</b>	<b>21</b>
<hr/>	
Color Code of the Shims	21
Shimming Table	21
Mount Change Accessories	22
Glossary	23

# Introduction

In this manual you learn how to change the mount of a ZEISS Lightweight Zoom LWZ.3 21-100/T2.9-3.9 T\* (abbreviation: ZEISS LWZ.3) and how to match it to a digital camera. In order to explain the procedure, this manual uses a ZEISS LWZ.3, which is scaled in feet with PL mount. Proceed in the same sequences to switch from or to any other mount that is available for the ZEISS LWZ.3 (Canon<sup>1</sup> EF, Nikon<sup>2</sup> F, Sony<sup>3</sup> E and MFT).

## Explanation of Symbols

---



The information symbol indicates additional information, which is useful for the context.



The skip symbol indicates that under certain circumstances you can skip certain steps.



The result symbol indicates information about the obtained result of a step.



The warning symbol indicates dangerous situations and actions, which might impair the functionality of the product, damage the product or hurt the user.

<sup>1</sup> Canon is a trademark or registered trademark of Canon Inc. and/or other members of the Canon Group.

<sup>2</sup> Nikon is a registered trademark of Nikon Corporation

<sup>3</sup> Sony and E-mount are registered trademarks of Sony Corporation

## Overview

- |          |               |           |                                      |
|----------|---------------|-----------|--------------------------------------|
| <b>1</b> | front lens    | <b>9</b>  | electrical contact                   |
| <b>2</b> | focus ring    | <b>10</b> | rear lens                            |
| <b>3</b> | lens foot     | <b>11</b> | groove of the lens                   |
| <b>4</b> | index mark    | <b>12</b> | shims                                |
| <b>5</b> | aperture ring | <b>13</b> | mount including the black inner ring |
| <b>6</b> | zoom ring     | <b>14</b> | T3 screws                            |
| <b>7</b> | lens barrel   | <b>15</b> | T6 screws                            |
| <b>8</b> | small screw   |           |                                      |

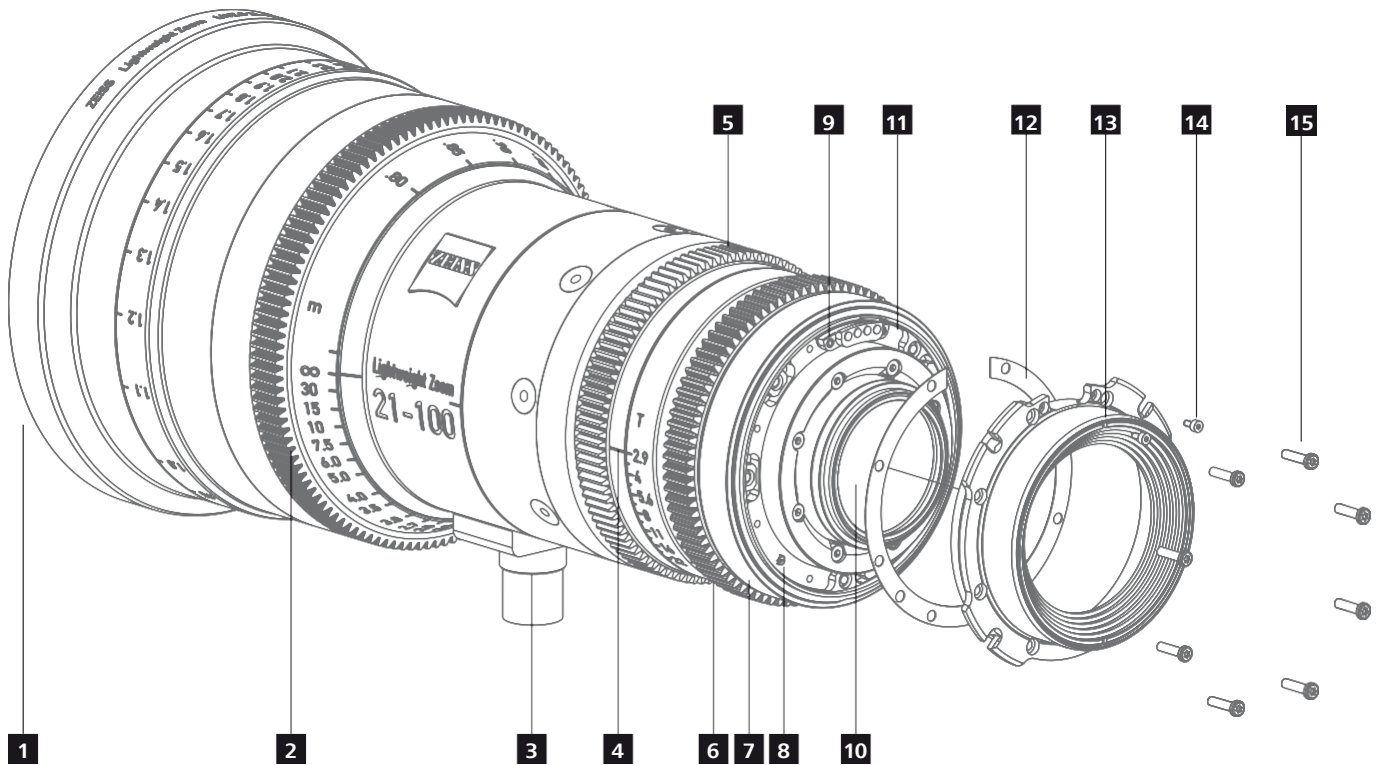

## Delivery Contents of a ZEISS LWZ.3

- 1x ZEISS LWZ.3
- 1x Front cap
- 1x Rear cap
- 1x Focus lever
- 3x Lens support riser 3/8"

---

## Technical Data

### **ZEISS Lightweight Zoom LWZ.3**

Focal length	21–100 mm
Aperture range	2.9 to 22
Lens elements / Groups	22 lenses / 18 groups
Close focus <sup>1</sup>	0.8 m / 2'8"
Rotation angle of focusing ring (inf – MOD)	294°
Zoom rotation angle	100°
Aperture rotation angle	48°
Front diameter	114 mm / 4.49"
Length <sup>2</sup>	226 mm / 8.9"
Weight	2.0 kg / 4.4 lbs
Aperture blades	11
Coverage	ANSI Super 35 / 31.1mm
Mounts	PL, EF, E, MFT, F
Horizontal Angle of View	61–9°
Super 35 <sup>3</sup>	61–14°
Normal 35 <sup>4</sup>	55–12°
APS-C <sup>5</sup>	56–13°
MFT <sup>6</sup>	45–9°

<sup>1</sup> Close focus distance is measured from the image plane

<sup>2</sup> Front to PL-mount flange

<sup>3</sup> Horizontal angle of view for an ANSI Super 35 Silent camera  
(aspect ratio 1:1.33, dimensions 24.9 mm x 18.7 mm / 0.98" x 0.74")

<sup>4</sup> Horizontal angle of view for a Normal 35 Academy camera  
(aspect ratio 1:1.37, dimensions 22 mm x 16 mm / 0.87" x 0.63")

<sup>5</sup> Horizontal angle of view for an APS-C camera  
(aspect ratio 1:1.50, dimensions 22.3 mm x 14.9 mm / 0.88" x 0.59")

<sup>6</sup> Horizontal angle of view for a Micro 4/3 (MFT) camera  
(aspect ratio 1:1.33, dimensions 17.3 mm x 13 mm / 0.68" x 0.51")

# Changing the Mount of a ZEISS LWZ.3

In this chapter you learn how to change the mount of a ZEISS LWZ.3. The procedure consist of parts which are both mandatory to successfully change a mount. You learn how to detach the currently attached mount and how to attach a different mount. To make sure the ZEISS LWZ.3 works properly, additionally complete the subsequent procedure:

2

[Adjusting a ZEISS LWZ.3 to Your Digital Camera.](#)

---

## Detaching a Mount

### You need

- ZEISS LWZ.3
- ZEISS T6 torque wrench with a torque of 0.4 Nm  
alternatively: regular T6 torque wrench with a torque of 0.4 Nm
- ZEISS T3 torque wrench with a torque of 0.05 Nm  
alternatively: regular T3 torque wrench with a torque of 0.05 Nm
- ZEISS Interchangeable Mount Set for ZEISS LWZ.3



The use of tools offered by ZEISS is highly recommended. You can purchase these tools directly from ZEISS or your trusted ZEISS dealer. See [Mount Change Accessories](#)

### Requirements

- Ensure that your working space is flat and leveled, in order to prevent the lens from tilting and falling over.
- Ensure that the environment is clean and free from dust so that no dust particles enter the ZEISS LWZ.3.
- Ensure that the front lens cap sits on your ZEISS LWZ.3, in order to avoid scratches.

1. Place your ZEISS LWZ.3 on a flat surface with the mount facing up and the serial number facing away from you.



The serial number is located at the side of the lens foot.  
The serial number varies.

2. Remove the rear lens cap.



You can now see the mount.



If you are changing from any other mount than a PL mount, skip step 3 since the electrical contact is not exposed on other mounts.

3. With a T3 torque wrench remove the 2 smaller and shorter torx screws which hold the electrical contact.





4. With a T6 torque wrench remove the remaining torx screws of the mount.



The black inner ring is securely fastened to the mount at the ZEISS factory and does not need to be removed.



The mount is now loose.

5. Carefully detach the mount from your ZEISS LWZ.3.

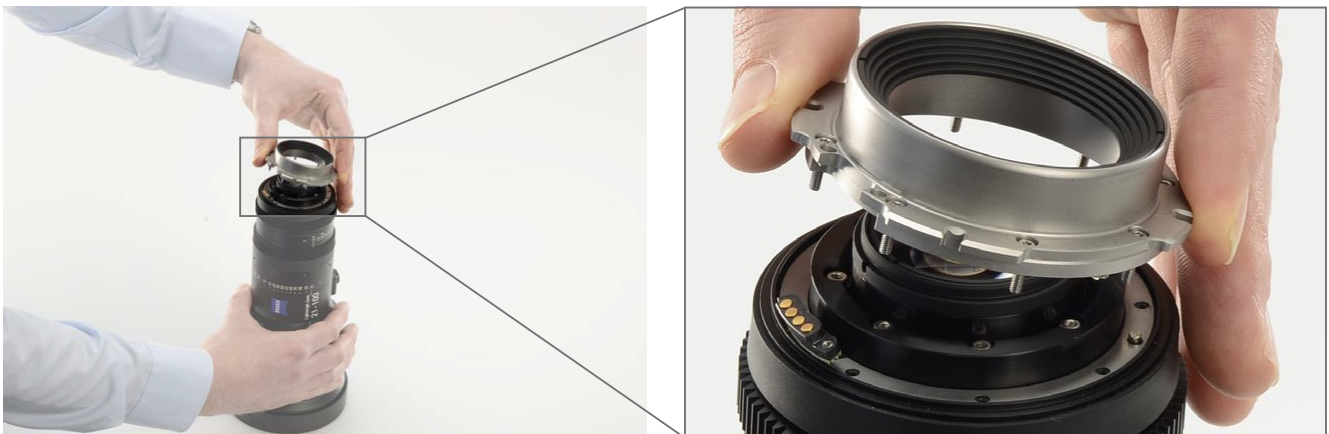

If you are changing from a PL mount, you can directly see the shims.  
If you are changing from any other mount than a PL mount, you can now see the black adapter ring.



If you are changing from a PL mount, skip Step 6 and 7, since the PL mount doesn't have an adapter ring.



6. With a T6 torque wrench remove the torx screws of the black adapter ring.



The shape and height of the black adapter ring varies according to the different mounts.



The black adapter ring is now loose.

7. Detach the black adapter ring from your ZEISS LWZ.3.



**1** groove of the lens **2** shims **3** small screw in the groove of the lens





Now you see the shim(s) and a small screw in the groove of the lens barrel.  
You successfully detached the mount.



When detaching the mount for the first time, do not remove the shims.  
Never remove the small screw in the groove of the lens.

---

## Screws required in order to attach an interchangeable mount

	PL	LPL	EF	EF Spacer	E	E Spacer
LWZ.3	M2x8	M2x8	M2x8	M2x10	M2x8	M2x10

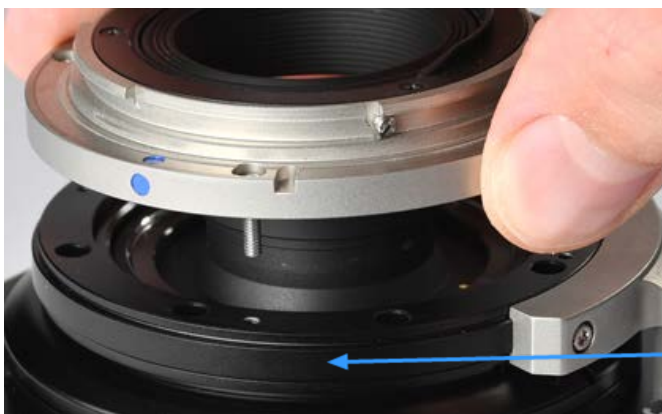

EF-Mount Spacer

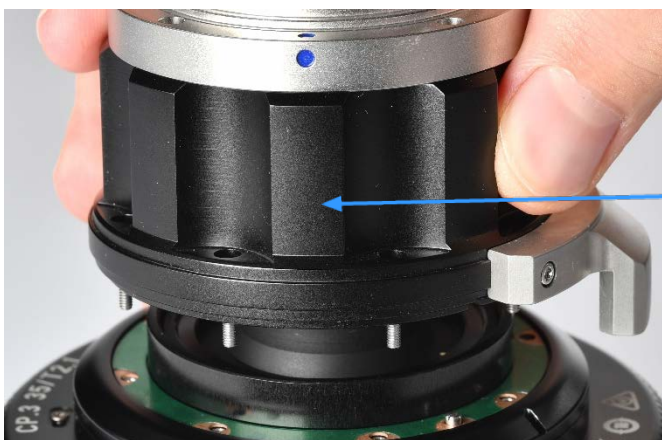

E-Mount Spacer

## Attaching a Mount

### You need

- ZEISS LWZ.3
- ZEISS T6 torque wrench with a torque of 0.4 Nm
- ZEISS T3 torque wrench with a torque of 0.05 Nm
- ZEISS Interchangeable Mount Set for ZEISS LWZ.3



The use of tools offered by ZEISS is highly recommended. You can purchase these tools directly from ZEISS or your trusted ZEISS Dealer. See [Mount Change Accessories](#)

---

## Requirements

- Ensure that your working space is flat and leveled, in order to prevent the lens from tilting and falling over.
- Ensure that the environment is clean and free from dust so that no dust particles enter the ZEISS LWZ.3.
- Ensure that the front lens cap sits on your ZEISS LWZ.3, in order to avoid scratches.
- Make sure you successfully completed Part 1: [Detaching a Mount](#)



If you are changing to a PL mount, skip Steps 1 and 2 in this chapter.

**1.** Carefully place the adapter ring, which came with your ZEISS Interchangeable Mount Set for the ZEISS LWZ.3. Make sure the small screw in the groove of the ZEISS LWZ.3 sinks into groove of the adapter ring and the electrical contact fits into the recess.



The shape and height of the black adapter ring varies according to the different mounts.

**2.** With the T6 torque wrench tighten the torx screws using a torque of 0.4 N



---

**3.** Place the mount on your ZEISS LWZ.3:

**3.I** PL mount: Place the PL mount on the ZEISS LWZ.3 in such a way that the recess of the mount lays on top of the electrical contact. The groove on the other side of the PL mount should then also lay on top of the small screw on the lens barrel. Screw in the 2 shorter T3 screws to fix the electrical contact.



**3.II** EF mount: Place the silver EF mount on the adapter ring in such a way that the notch aligns with the index mark.



**3.III** F mount: Place the F mount on the adapter ring in such a way that the notch aligns with the index mark.



**3.IV** MFT mount: Place the MFT mount on the adapter ring in such a way that the notch aligns with the index mark.





---

**3.V** E mount: Place the E mount on the adapter ring in such a way that the blue dot aligns with the index mark.



---

**4.** With the T6 torque wrench tighten the torx screws using a torque of 0.4 N



You now successfully changed the mount of a ZEISS LWZ.3.

In this chapter you learned how to detach the mount of your ZEISS LWZ.3 and attach a new mount to your ZEISS LWZ.3. To make sure your ZEISS LWZ.3 works properly, also complete the subsequent procedure: [Adjusting a ZEISS LWZ.3 to Your Digital Camera](#)

# Adjusting a ZEISS LWZ.3 to Your Digital Camera

In the following chapter you learn how to adjust your ZEISS LWZ.3 to a digital camera. This is necessary to ensure that the ZEISS LWZ.3 works properly and delivers the maximum image quality. In order to perform this adjustment, ZEISS provides shims in different colors which indicate their thickness.

## You need:

- Tripod
- Digital camera with live view
- ZEISS LWZ.3 that needs to be adjusted
- Siemens star test chart
- Measuring tape or folding ruler
- Flat-blade screwdriver
- At least 3,5 m or 12 ft of free space
- ZEISS Interchangeable Mount Set for ZEISS LWZ.3  
alternatively: ZEISS Shims set



The use of tools offered by ZEISS is highly recommended. You can purchase these tools directly from ZEISS or your trusted ZEISS Dealer. See [Mount Change Accessories](#)

## Requirements:

- Make sure that the front and rear lens of the ZEISS LWZ.3 are clean.
- Ensure that the illumination is bright and uniform.
- Set your camera to standard settings (cf. work settings)



Smudges and fingerprints on the lens surface can gently be removed with a soft brush and then with a dry and clean cotton cloth. The ZEISS lens cleaning kit will give superior results and is highly recommended for this purpose. For further information, please watch our tutorial on how to clean your lens. <https://youtu.be/syOzeczbtuwg>



---

## Testing the Sharpness

---

1. Fasten the siemens star test chart on a wall.
2. Mount the ZEISS LWZ.3 on the camera.
3. Mount the camera on a tripod.
4. Position your camera at the testing distance of 3 m or 10 ft.



The testing distance is measured from the siemens star test chart to image plane on your camera.



- 
5. Level the camera.

---

**6.** Set the aperture of the ZEISS LWZ.3 to T2.9 by rotating the aperture ring.



The aperture setting must not be changed during the adjustment process.

---

**7.** Activate the live view of your camera.

---

**8.** Select the maximum magnification of the live view.

---

**9.** Make sure that the center of the image aligns with the center of the siemens star test chart.

---

**10.** Set the focal distance of the ZEISS LWZ.3 to 100 mm by rotating the zoom ring.

---

**11.** Set the focus ring to 3 m or 10 ft.

---

**12.** Turn the focus ring to determine if the sharpness is located below 3 m/10 ft or above 3 m/10 ft.



This will give you an idea if you need to reduce or enlarge the distance of the camera to the siemens star test chart. You will need this information in a further step.

If you achieve the maximum sharpness at 3 m/10 ft, you successfully tested your ZEISS LWZ.3. No further steps are required.

---

**13.** Again, set the focus ring to 3 m or 10 ft.

---

**14.** Reduce or enlarge the distance between the siemens star test chart and the image plane of the camera by a maximum of 5 cm or 2" to obtain maximum image sharpness on the live view. Keep the focus ring at 3 m /10 ft.

- If you measured the sharpness below 3 m /10 ft you need to reduce the distance between the test chart and the image plane of the camera.
- If you measured the sharpness above 3 m /10 ft you need to enlarge the distance between the test chart and the image plane of the camera.



---

**15.** Now remeasure the testing distance between the image plane mark on the camera body and the test chart (= the actual distance)

- If the testing distance has changed, note the distance. The change indicates that the flange focal distance of the ZEISS LWZ.3 must be adjusted. Proceed with the steps in [Correcting the Flange Focal Distance](#).



Do not take down the setup as you will need it again to recheck the sharpness later in the process.

---

## Correcting the Flange Focal Distance

---

1. Remove the ZEISS LWZ.3 from the camera.
2. Follow the steps of chapter [Detaching a Mount](#).
3. Determine the total thickness of the shims that already lay in the lens groove.
4. Increase or decrease the total shim thickness according to the [Shimming Table](#) in the appendix.



Any combination of shims is possible to achieve the required thickness and therefore the desired flange focal distance. Always use the closest possible combination of shims.

Example: Using a ZEISS LWZ.3 with an EF mount, scaled in feet and a test chart at a test distance of 10 ft, an actual distance of 10 ft 1' is measured. Due to the shimming tables, you add a light blue shim 0.03 mm to the total thickness of the shims.

---

5. Use a flat-bladed screwdriver or a pair of tweezers to remove or add shims.



Handle the shims carefully as they can easily kink or tear which makes them unusable. Ensure that the colored shims lie on top of each other in the groove of the lens barrel and do not cover the screw holes. The shims might otherwise be damaged, while screwing in the screws.

---

6. Follow the steps of chapter [Attaching a Mount](#) to attach a new mount.

---

7. Recheck the sharpness of the lens by following the steps of chapter [Testing the Sharpness](#) once more. Check the sharpness at both 100 mm and 21 mm.











- a. If the testing distance has changed, follow the steps of chapter [Correcting the Flange Focal Distance](#) once more.
- b. If you achieve the maximum sharpness over the whole focal range, you successfully tested your ZEISS LWZ.3.

In this chapter you learned how to adjust a ZEISS LWZ.3.



# Appendix

## Color Code of the Shims

Shim color	Thickness [mm]	
Silver	0.013	
Gold	0.019	
Purple	0.025	
Light Blue	0.032	
Red	0.038	
Blue	0.051	
White	0.064	
Green	0.076	
Orange	0.102	
Light Purple	0.127	
Clear	0.152	

## Shimming Table

**Minus sign:** Enlarge the flange focal distance. → Remove Shims

**Plus sign:** Reduce the flange focal distance. → Add Shims

Meter distance scale		Feet distance scale	
Distance to test chart [mm]	3000	Distance to test chart [ft]	10
Object distance at best focus [mm]	Change of total washer thickness [mm]	Object distance at best focus [ft]	Change of total washer thickness [mm]
2960	-0,05	9ft 10'	-0,06
2970	-0,04	9ft 10 1/2'	-0,05
2980	-0,02	9ft 11'	-0,03
2990	-0,01	9ft 11 1/2'	-0,02
3000	0,00	10ft 0'	0,00
3010	+0,01	10ft 1/2'	+0,02
3020	+0,02	10ft 1'	+0,03
3030	+0,04	10ft 1 1/2'	+0,05
3040	+0,05	10ft 2'	+0,06

---

## Mount Change Accessories

<b>Accessories</b>	<b>ZEISS Identification Number</b>
Interchangeable Mount Set PL for LWZ.3	2152-131
Interchangeable Mount Set EF	2152-130
Interchangeable Mount Set F	2152-133
Interchangeable Mount Set E	2152-132
Interchangeable Mount Set MFT	2152-134
Front Lens Cap ZEISS LWZ.3	2153-707
Rear Lens Cap PL	102160-0052-000
Rear Lens Cap EF	1793-167
Rear Lens Cap F	1793-178
Rear Lens Cap E	1907-145
Rear Lens Cap MFT	1889-118
Torx torque wrench (T6, torque moment 0,4 Nm)	0520-065
Torx torque wrench (T3, torque moment 0,5 Nm)	0604-200
ZEISS Siemens Star Test Chart	1849-755
Colored Shims ZEISS LWZ.3 (Set)	2143-589

---

## Glossary

---

<b>Flange focal distance</b>	flange-to-film distance, flange focal depth, flange back distance, flange focal length
<b>Shim</b>	washer
<b>Index mark</b>	aperture indicator, aperture line, aperture mark, aperture index
<b>Flat-blade screwdriver</b>	slotted screwdriver, flathead screwdriver

---

**Carl Zeiss AG**  
Camera Lenses  
73446 Oberkochen  
Germany

Phone +49 7364 20-6175  
Fax: +49 7364 20-4045  
[www.zeiss.com/cine](http://www.zeiss.com/cine)